



AD120-25T Series

DC Axial Fan

120x120x25mm

Specification:

- **Air Flow** : 70 ~ 84 CFM
- **Housing** : Thermoplastic PBT, UL94V-0
- **Impeller** : Thermoplastic PBT, UL94V-0
- **Bearing** : Ball or Sleeve
- **Termination** : Lead Wire UL 1007 AWG#24 or Equivalent
Red Wire Positive (+); Black Wire Negative (-);
Yellow Wire Function (3)
- **Operating Temperature** : -10°C to + 70°C for Sleeve Type
-20°C to + 80°C for Ball Type
- **Weight** : 135g
- **Function** :
P: Protection (Automatic restart when lock up removed)
A: Alarm (optional)

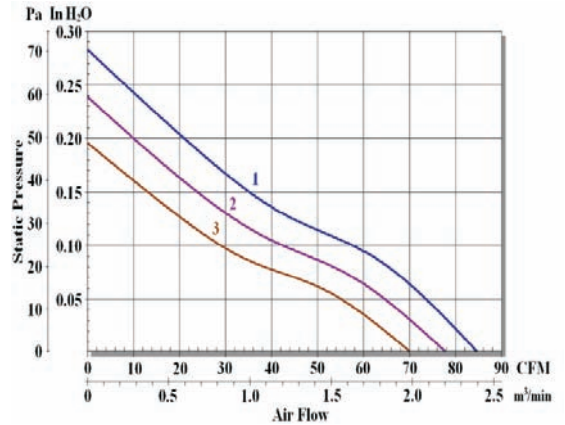

Outline Dimension

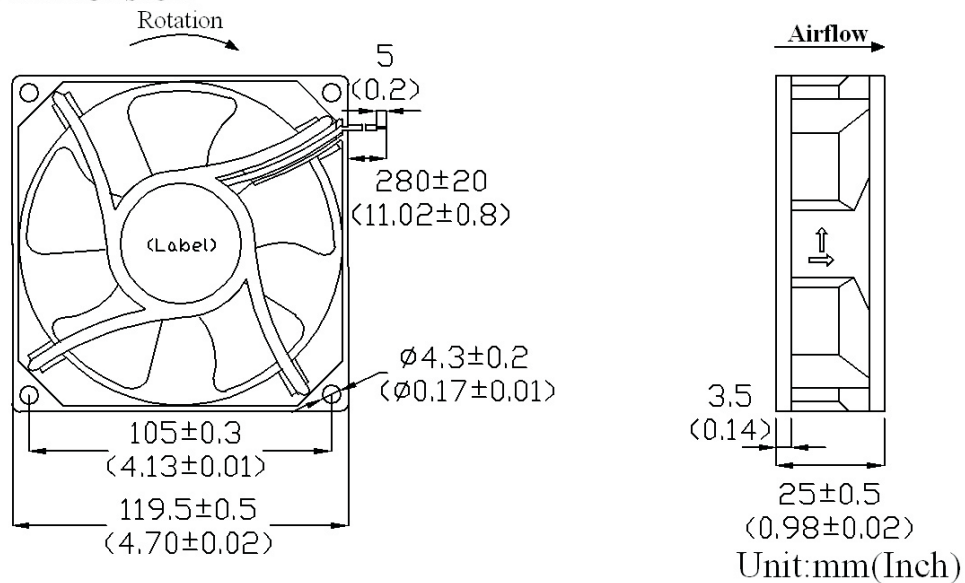

Item Code	Rated Voltage	Rated Current (A)	Input Power (W)	Speed RPM	Max. Air Flow		Noise dB(A)
					CFM	m ³ /min	
AD12V120-25T-FPH-B5-N1P	12V	0.36	4.3	3200	84	2.39	48
AD12V120-25T-FPH-B5-N2P	12V	0.29	3.5	2900	78	2.20	45
AD12V120-25T-FPH-B5-N3P	12V	0.20	2.4	2600	70	1.97	42
AD24V120-25T-FPH-B5-N1P	24V	0.19	4.7	3200	84	2.39	48
AD24V120-25T-FPH-B5-N2P	24V	0.15	3.6	2900	78	2.20	45
AD24V120-25T-FPH-B5-N3P	24V	0.12	2.9	2600	70	1.97	42
AD48V120-25T-FPH-B5-N1P	48V	0.11	5.3	3200	84	2.39	48
AD48V120-25T-FPH-B5-N2P	48V	0.08	3.8	2900	78	2.20	45
AD48V120-25T-FPH-B5-N3P	48V	0.07	3.4	2600	70	1.97	42