

80x80x25mm

AD80-25T Series

DC Axial Fan

Specification:

- **Air Flow** : 30 ~ 37 CFM
- **Housing** : Thermoplastic PBT, UL94V-0
- **Impeller** : Thermoplastic PBT, UL94V-0
- **Bearing** : Ball or Sleeve
- **Termination** : Lead Wire UL 1007 AWG#24 or Equivalent
Red Wire Positive (+); Black Wire Negative (-);
Yellow Wire Function (3)
- **Operating Temperature** : -10°C to + 70°C for Sleeve Type
-20°C to + 80°C for Ball Type
- **Weight** : 100g
- **Function** : *Function type is optional*
P: Protection (Automatic restart when lock up removed)
A: Alarm
I: Inspect

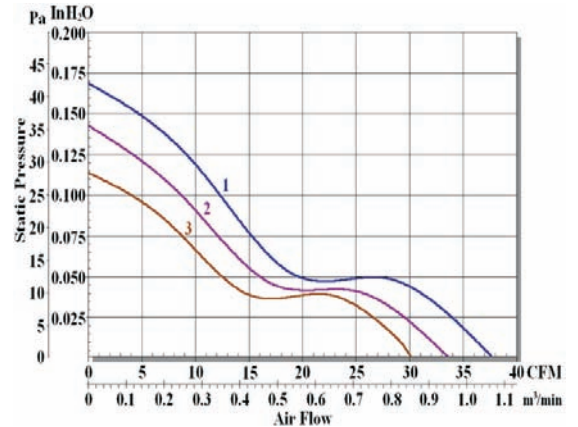

Outline Dimension

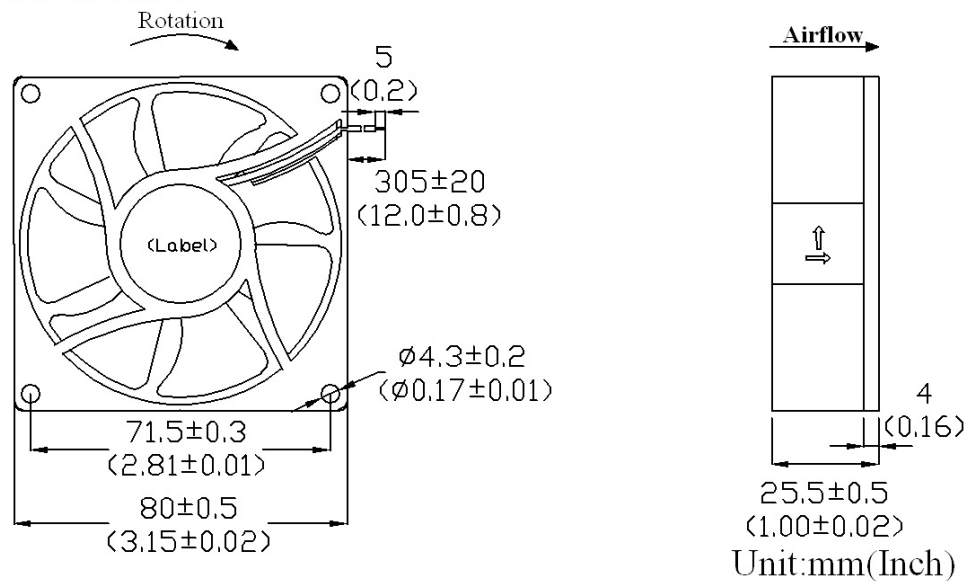

Item Code	Rated Voltage	Rated Current (A)	Input Power (W)	Speed RPM	Max. Air Flow		Noise dB(A)
					CFM	m³/min	
AD12V80-25T-FPH-B7-N1	12V	0.19	2.3	3200	37	1.06	37
AD12V80-25T-FPH-B7-N2	12V	0.14	1.7	2900	34	0.95	35
AD12V80-25T-FPH-B7-N3	12V	0.11	1.4	2600	30	0.86	31
AD24V80-25T-FPH-B7-N1	24V	0.10	2.4	3200	37	1.06	37
AD24V80-25T-FPH-B7-N2	24V	0.08	1.9	2900	34	0.95	35
AD24V80-25T-FPH-B7-N3	24V	0.07	1.7	2600	30	0.86	31
AD48V80-25T-FPH-B7-N1	48V	0.08	3.9	3200	37	1.06	37
AD48V80-25T-FPH-B7-N2	48V	0.07	3.4	2900	34	0.95	35
AD48V80-25T-FPH-B7-N3	48V	0.06	2.9	2600	30	0.86	31